

Instruções Peça 3

- 1 Recorte o contorno da figura.
- 2 Dobre nos lugares indicados

— cortar
- - - dobrar

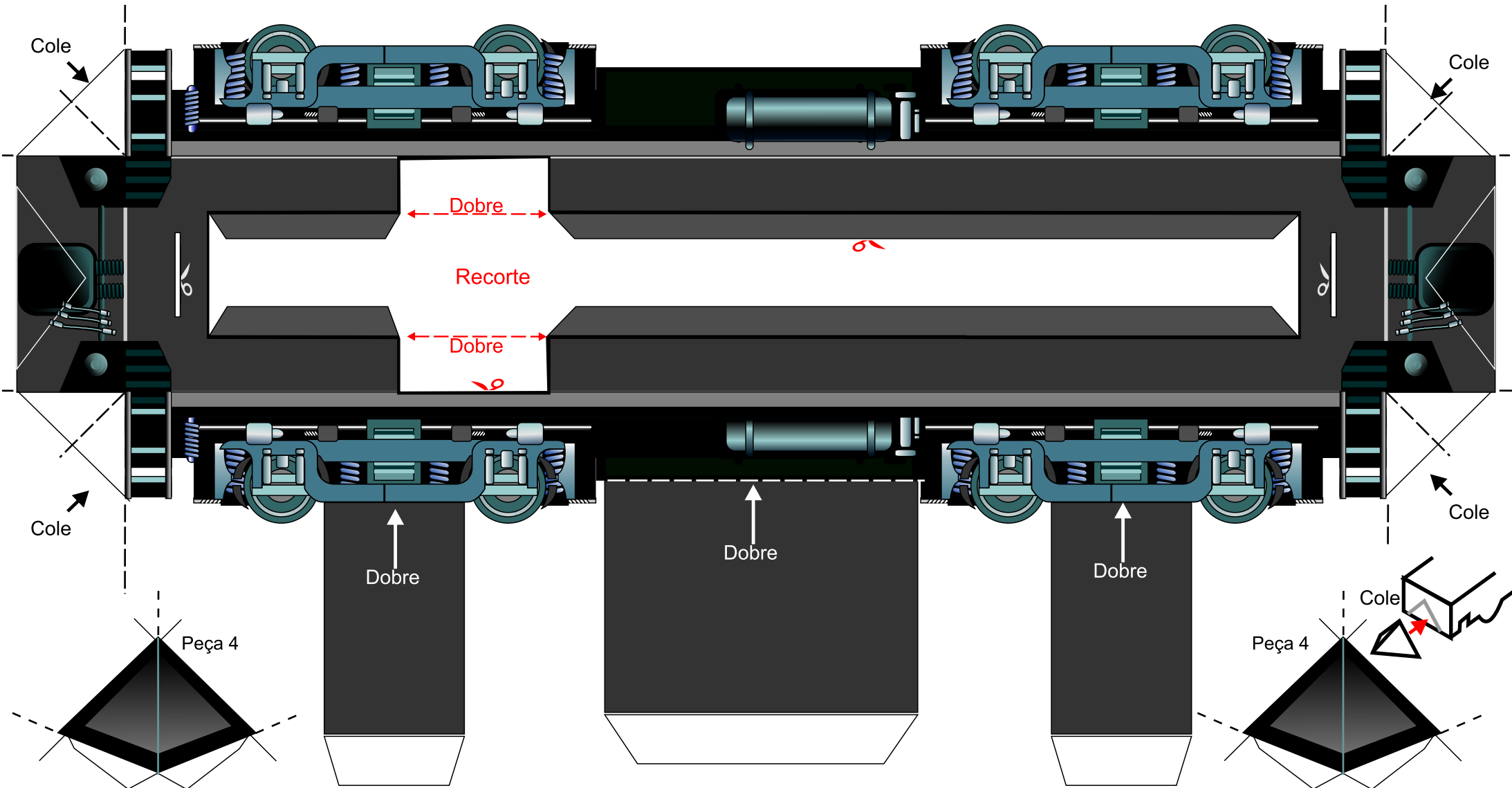

Instruções Peça 2

- 1 Recorte o contorno da figura.
- 2 Dobre nos lugares indicados
- 3 Monte conforme a figura 2



figura 2

- 4 Dobre e Cole as bandeirinhas em um palitinho. (conforme figura 3)
Você pode pintar os palitinhos na cor preta.



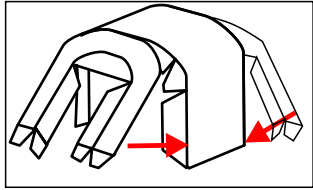
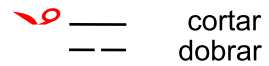

figura 3

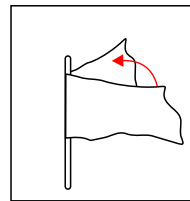
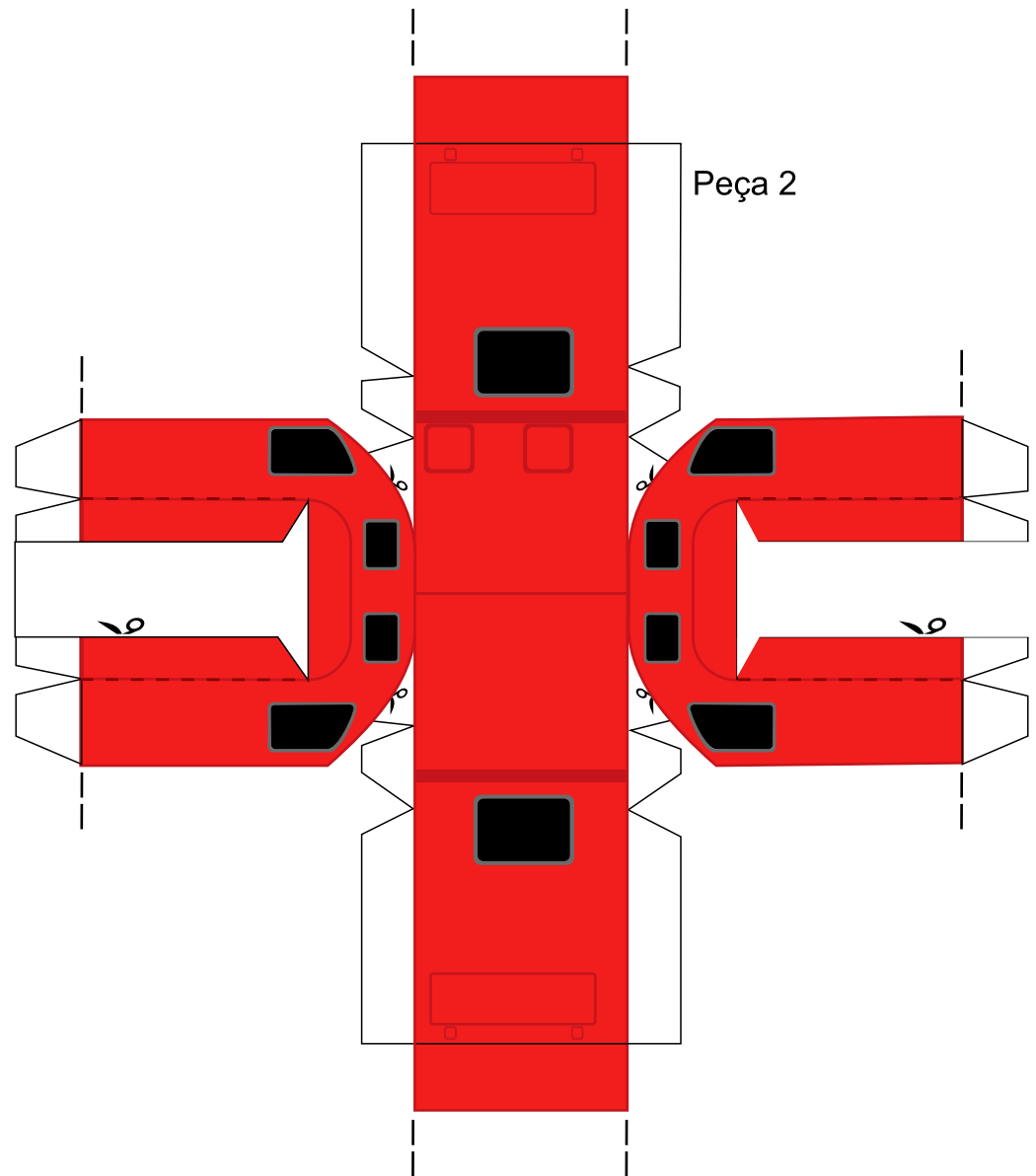
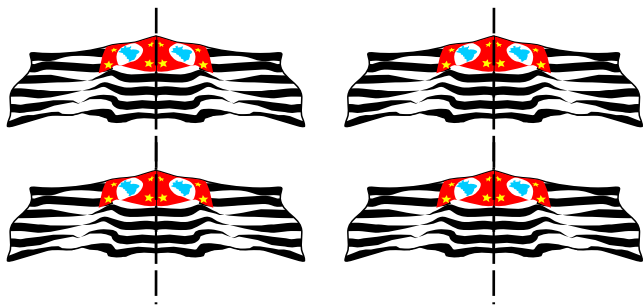

Instruções Vagão Peça B

1 Recorte o contorno da figura.

 — cortar

Vagão Peça B

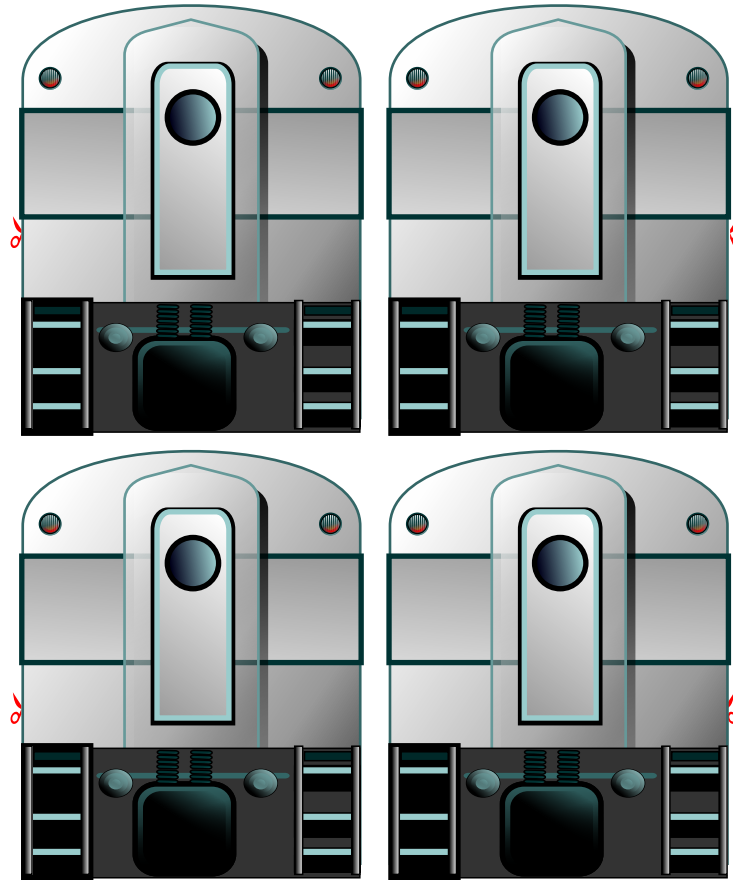

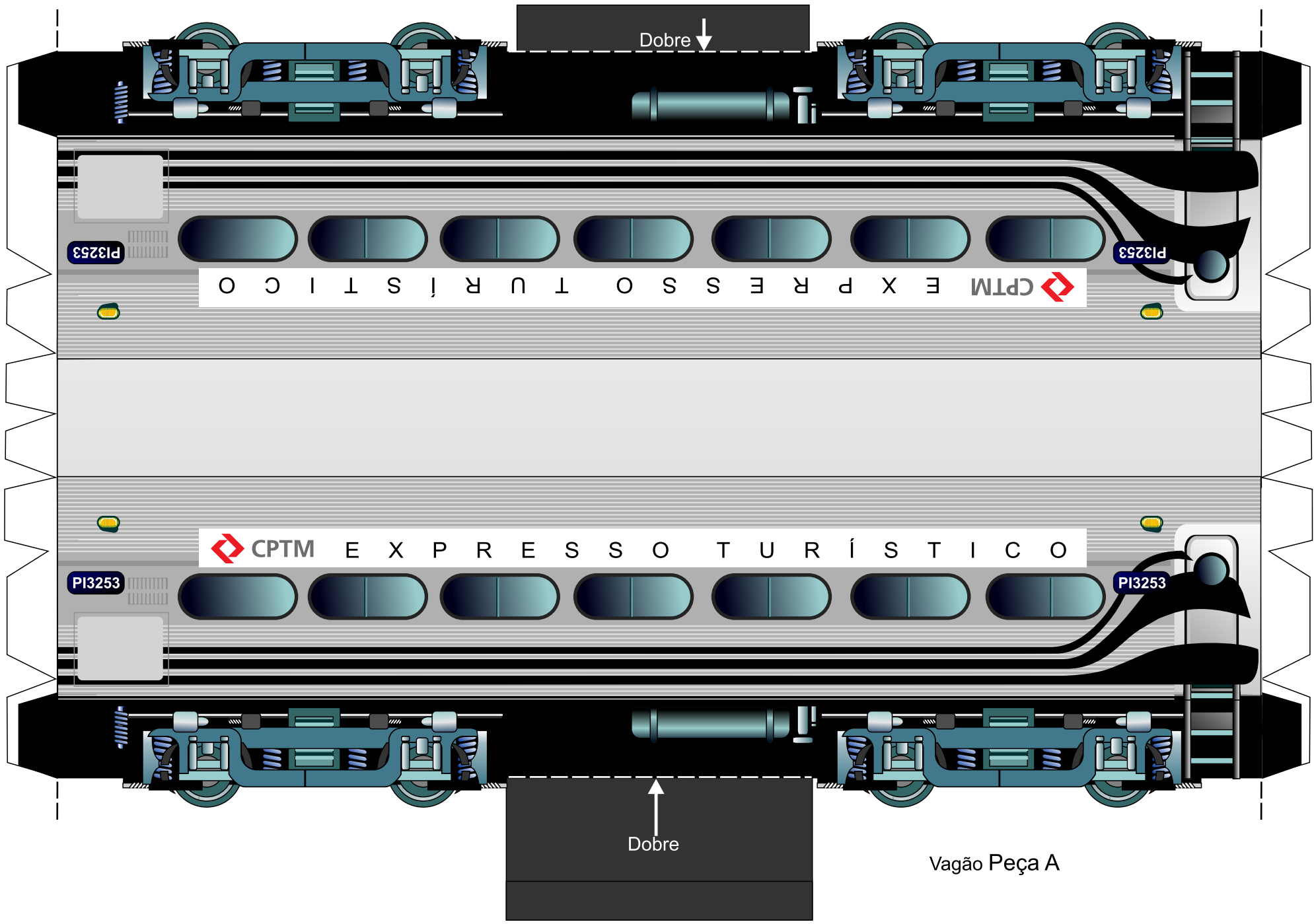

Dobre ↓

PI3253

PI3253

CPTM EXPRESSO TURÍSTICO

PI3253

PI3253

CPTM EXPRESSO TURÍSTICO

Dobre ↑

Vagão Peça A

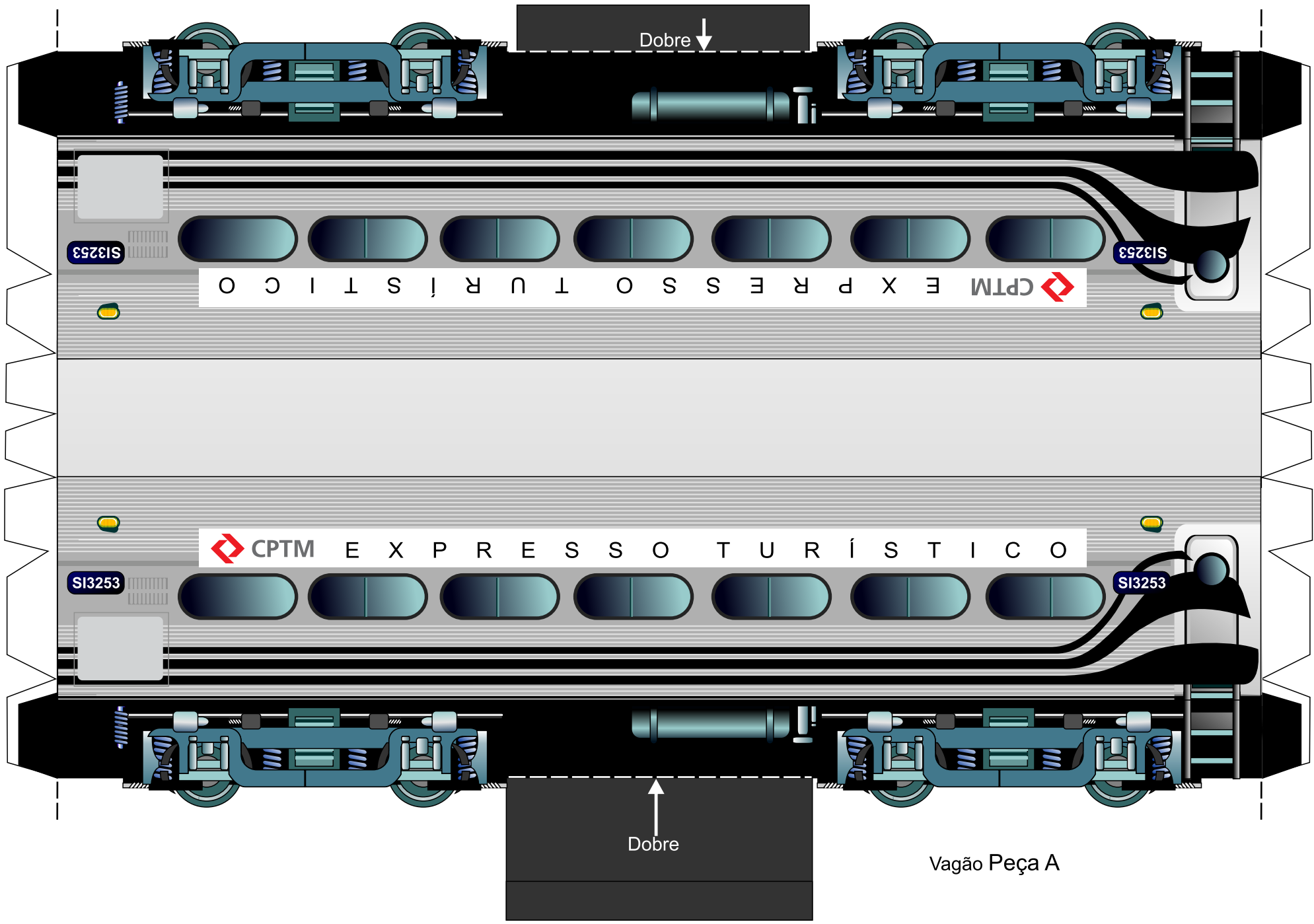

Instruções

Montagem da locomotiva



figura 4



figura 3

Montagem do vagão

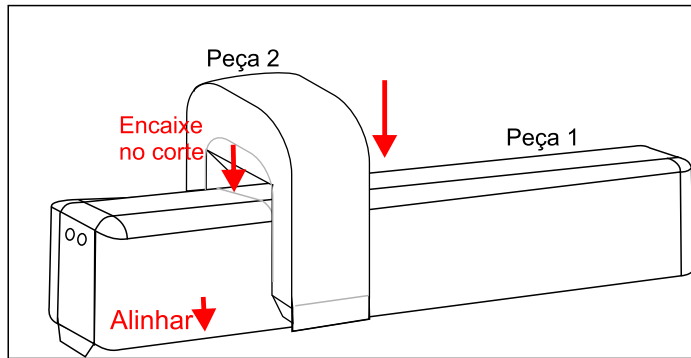
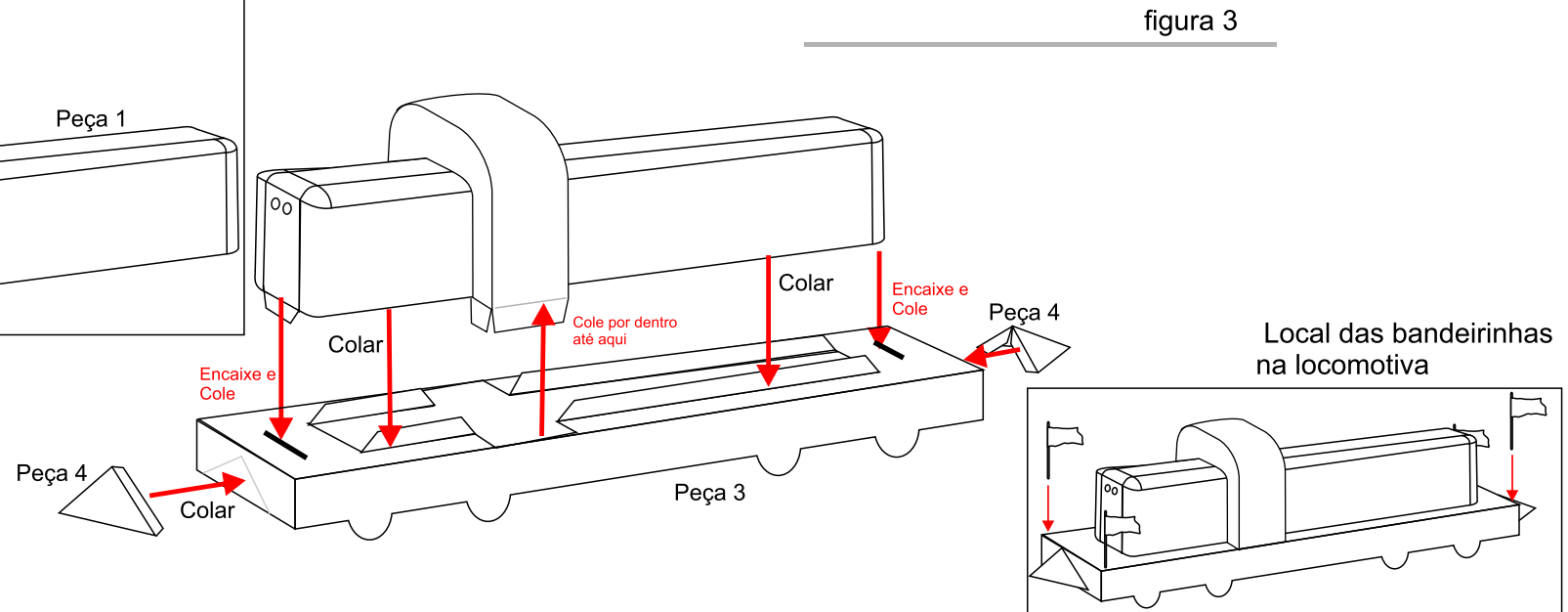
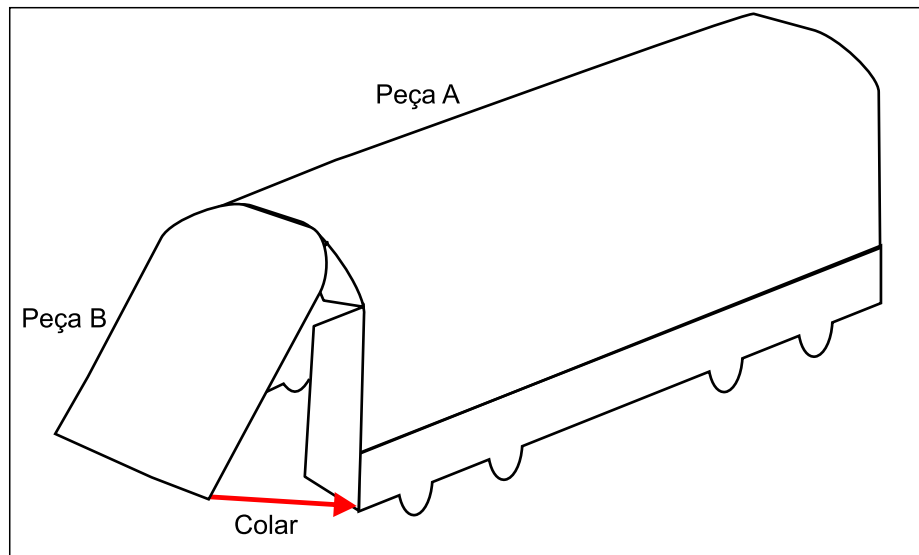

figura 5